

SPECIFICATIONS

材质Material:

绝缘体 (Insulator): Polyester (UL94V-0)
Standard: PBT Black

接触件Contacts: Brass

接触电镀Contact Plating: Au or Sn over 30 μ" Ni

电气性能Electrical Characteristics:

接触电阻Contact Resistance: 20mΩ Max.

绝缘电阻Insulator Resistance: 1000MΩ Min.

耐电压Withstanding Voltage: AC 500V

额定电流Current Rating: 3 AMP

适用温度范围Operating Temperature: -40°C to +105°C

耐温性能Temperature resistancet: 205°C ±5°C, 3s-5s max

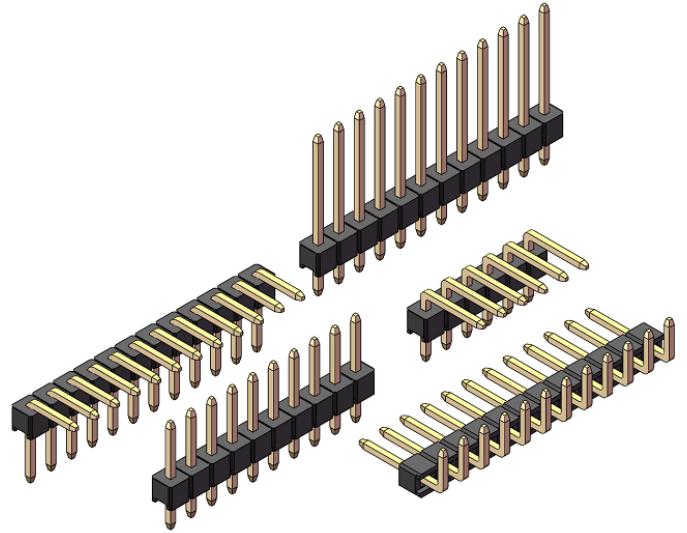

Unit: mm

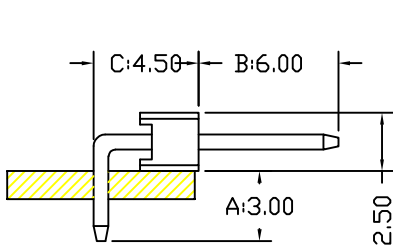
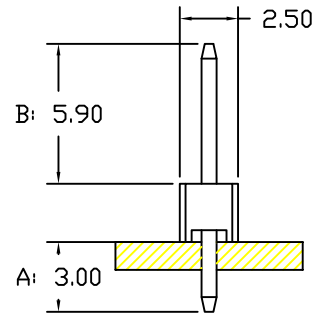
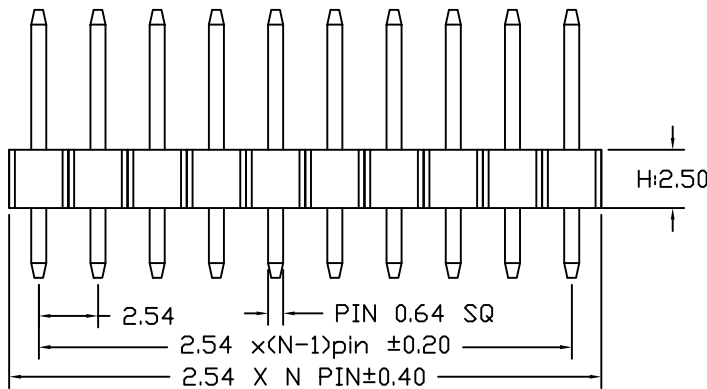

R1 Type (顶弯)

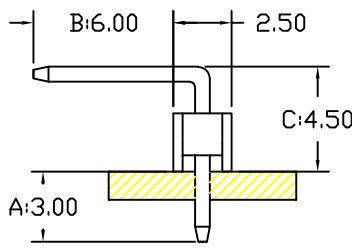

R2 Type (普弯)

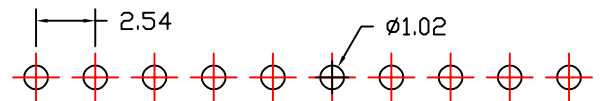

PCB LAYOUT

订购方法 How To Order

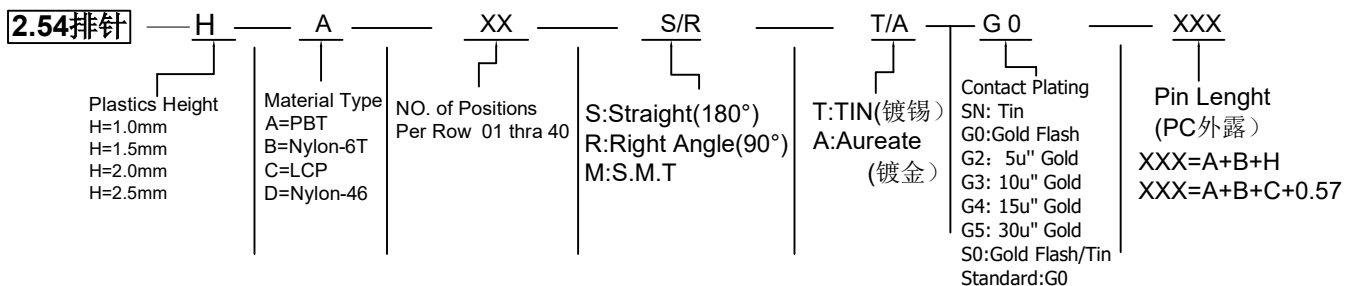

常规表达: 型号 (2.54单排针座) - 胶芯高度 (H) - 材质 (PBT) - 规格 (1*XXP) - 类型 (S/R) - 接触件镀层 (XXU") - 尺寸 (XXX)

* 其它要求的产品另外说明 Other requests's product on the other hand description