

SPECIFICATIONS

材质Material:

绝缘体 (Insulator): Polyester (UL94V-0)
Standard: PBT Black

接触件Contacts: Brass or Phosphor Bronze

接触电镀Contact Plating: Au or Sn over $30\mu\text{m}$ Ni

电气性能Electrical Characteristics:

接触电阻Contact Resistance: $20\text{m}\Omega$ Max.

绝缘电阻Insulator Resistance: $5000\text{M}\Omega$ Min. At 500V DC

耐电压Withstanding Voltage: 1000V AC/Minute

额定电流Current Rating: 3 AMP

耐温性能Temperature resistance: $205^\circ\text{C} \pm 5^\circ\text{C}$, 3s-5s max

插入力Insertion Force: 0.4Kgf Max. Per Pair

拔出力Withdrawal Force: 0.25Kgf Max. Per Pair

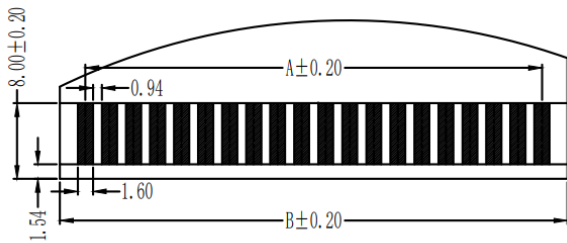
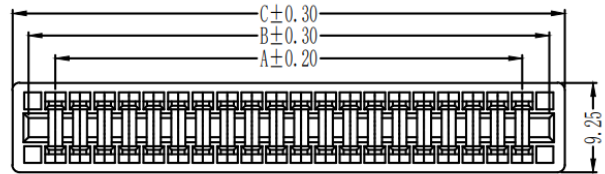
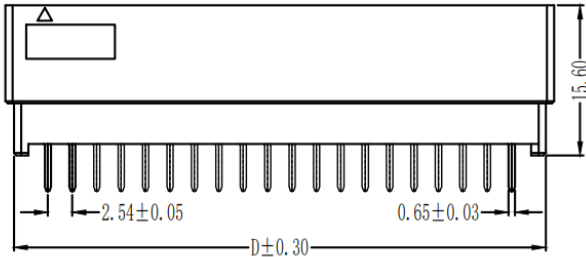
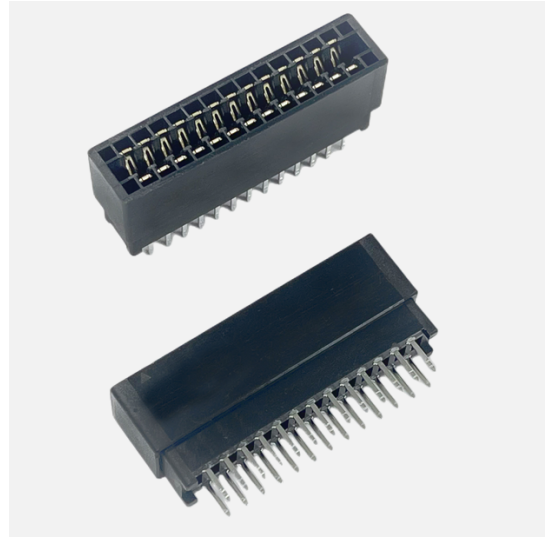

Recommended Card Layout

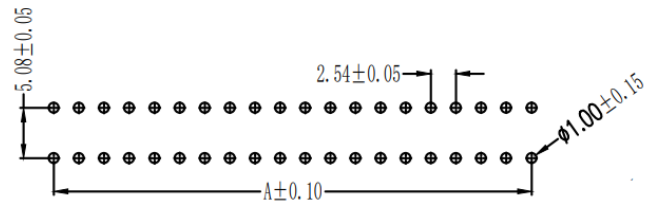

Recommended P.C.B. Layout

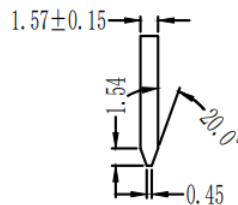
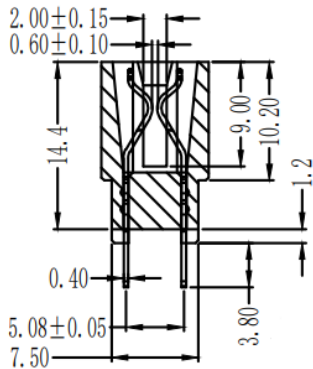

可选Pin数: 4-128 Pins
Number Of Pins: 4-128 Pins

* 其它要求的产品另外说明 Other requests's product on the other hand description